

Data Sheet

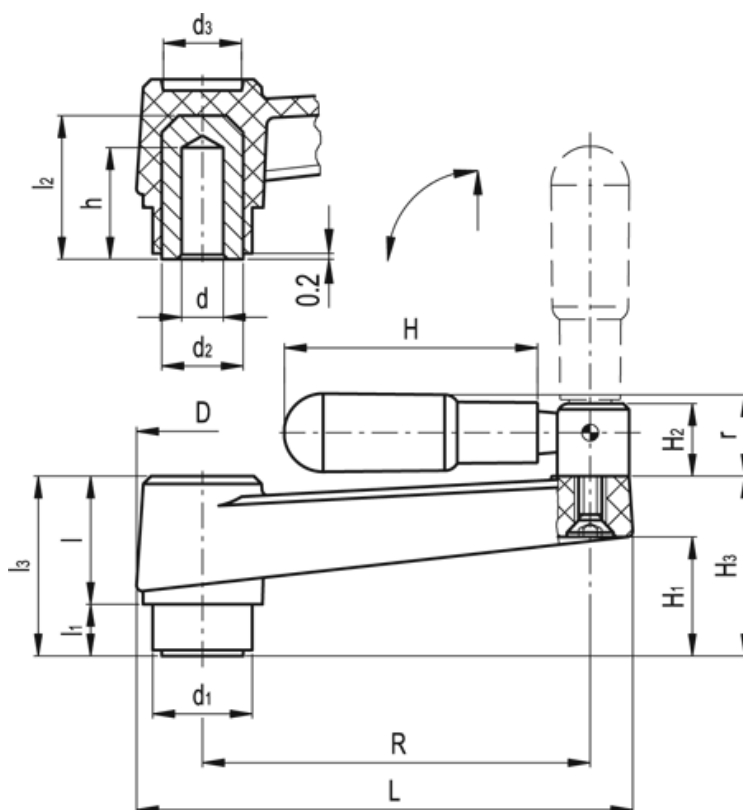

Article number: 2301044517
Description: E+G Crank handle
MT.160-AT+IR

Measures



D = 45	H2 = 19	r = 21.5
d1 = 34.0	H3 = 55.5	Weight (g) = 330
d2 = 26	L = 197	
d3 = 27	l = 40	
d H7 = 16	l1 = 15	
H = 80	l2 = 43	
h = 30	l3 = 55	
H1 = 38.0	R = 160	